

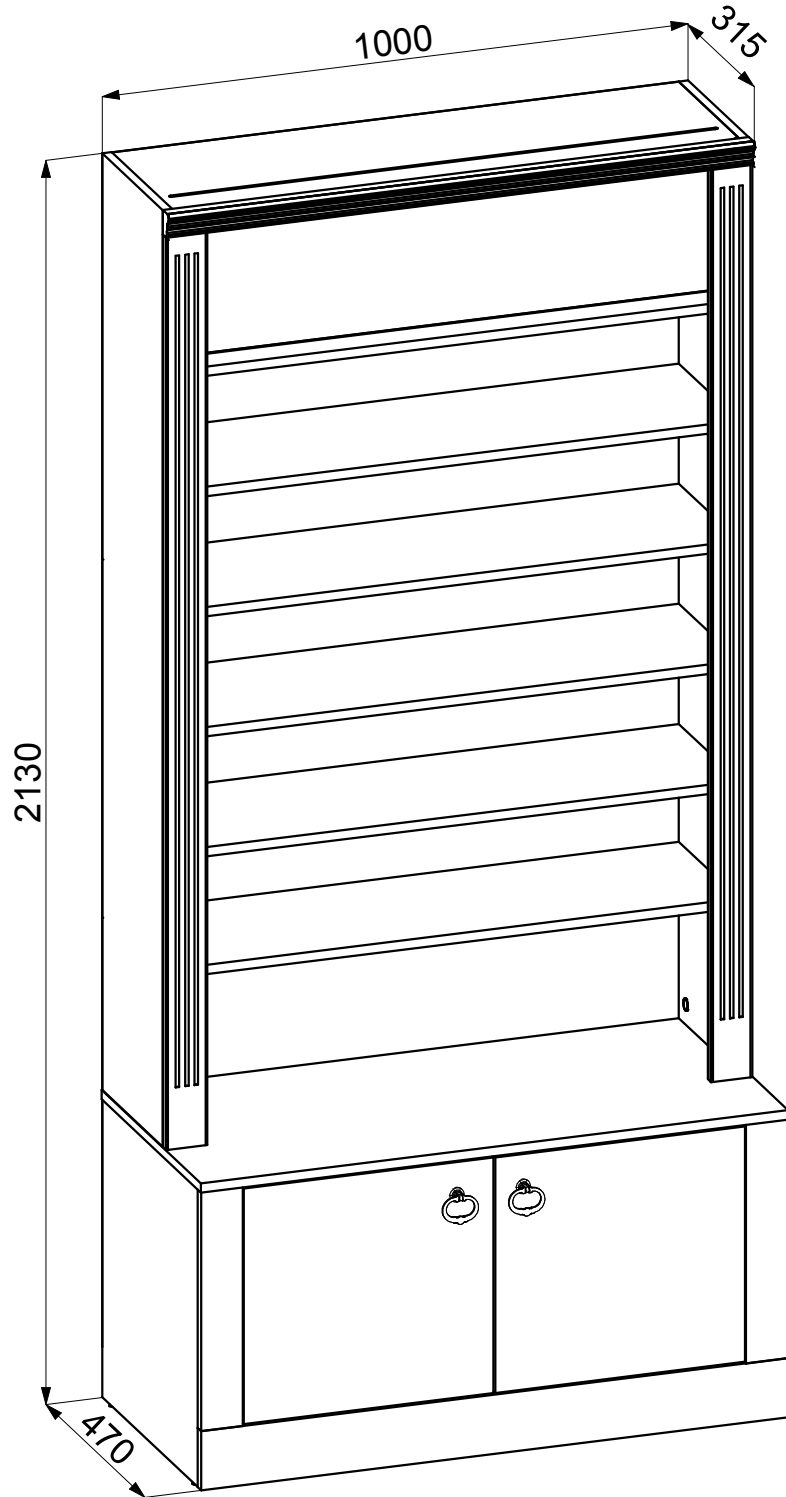

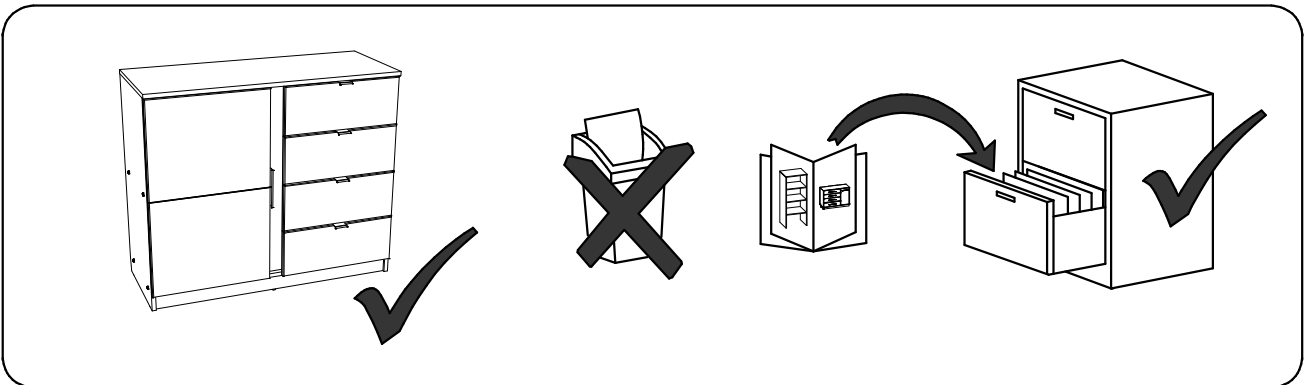

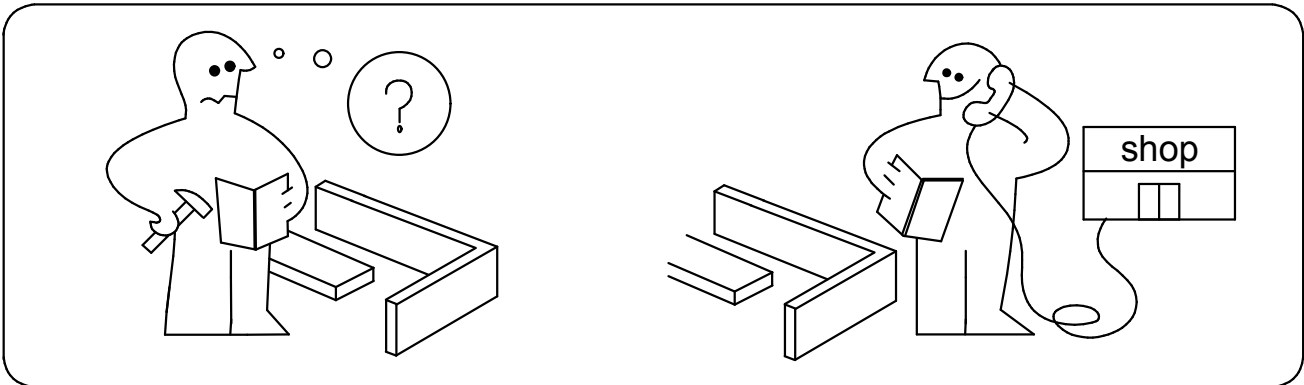

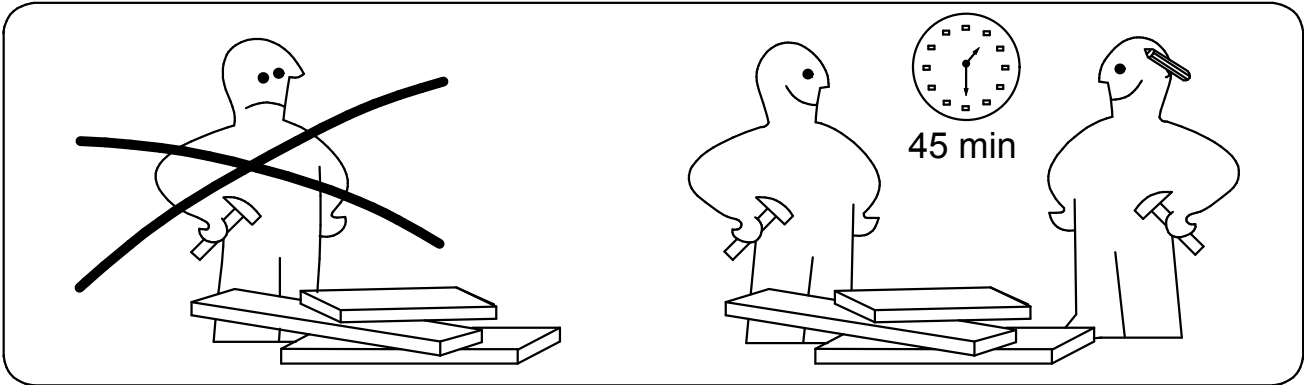

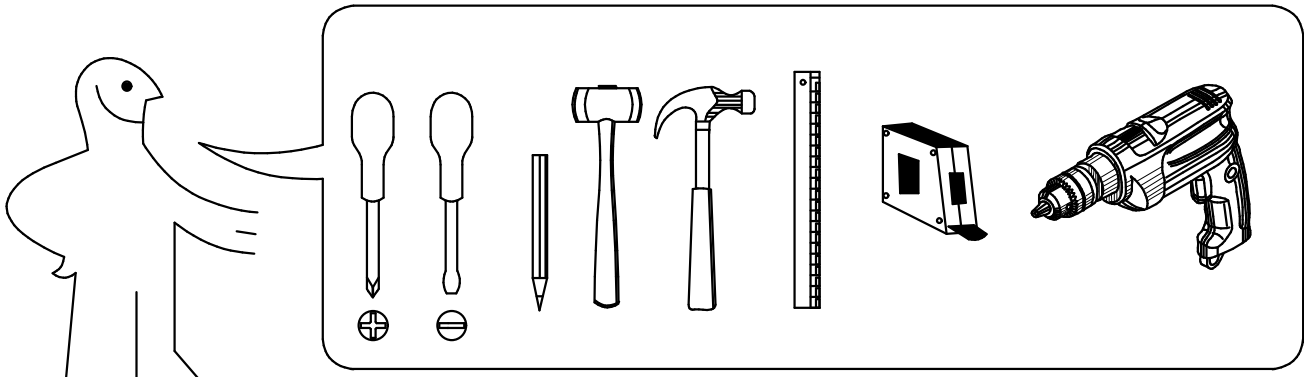
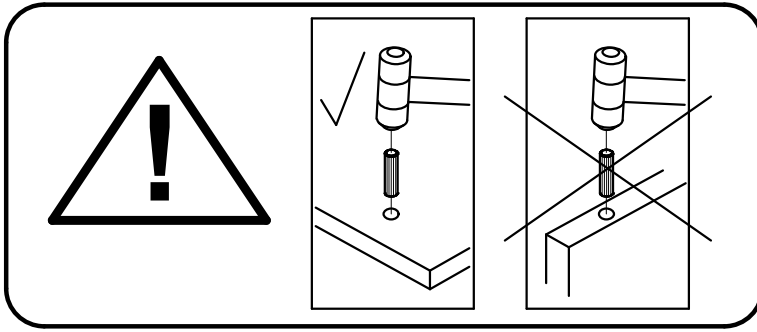

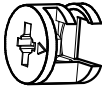
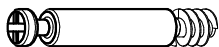

# H&H Wall Display



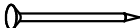
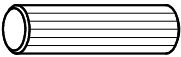

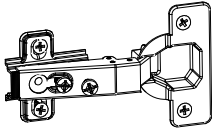

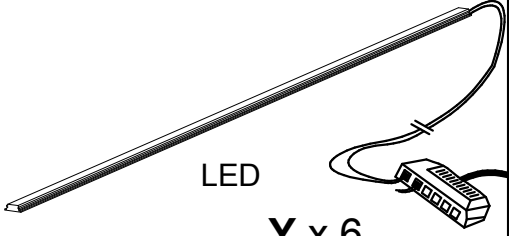
 Ø6,3x50 mm <b>A1 x 2</b>	 Ø12 mm <b>A2 x 2</b>	 4 mm <b>A3 x 1</b>	 Ø15x12 mm <b>B1 x 37</b>	 Ø5x44 mm <b>B2 x 37</b>
 Ø20 mm <b>B3 x 37</b>	 Ø4x16 mm <b>D1 x 16</b>	 Ø4,0x30 mm <b>D2 x 2</b>	 Ø1,6x25 mm <b>F x 125</b>	 Ø8x36 mm <b>G x 76</b>
 <b>H x 2</b>	 Ø5x16 mm <b>L x 2</b>	 <b>M x 4</b>	 Ø15 mm <b>N x 6</b>	
 LED <b>Y x 6</b>				

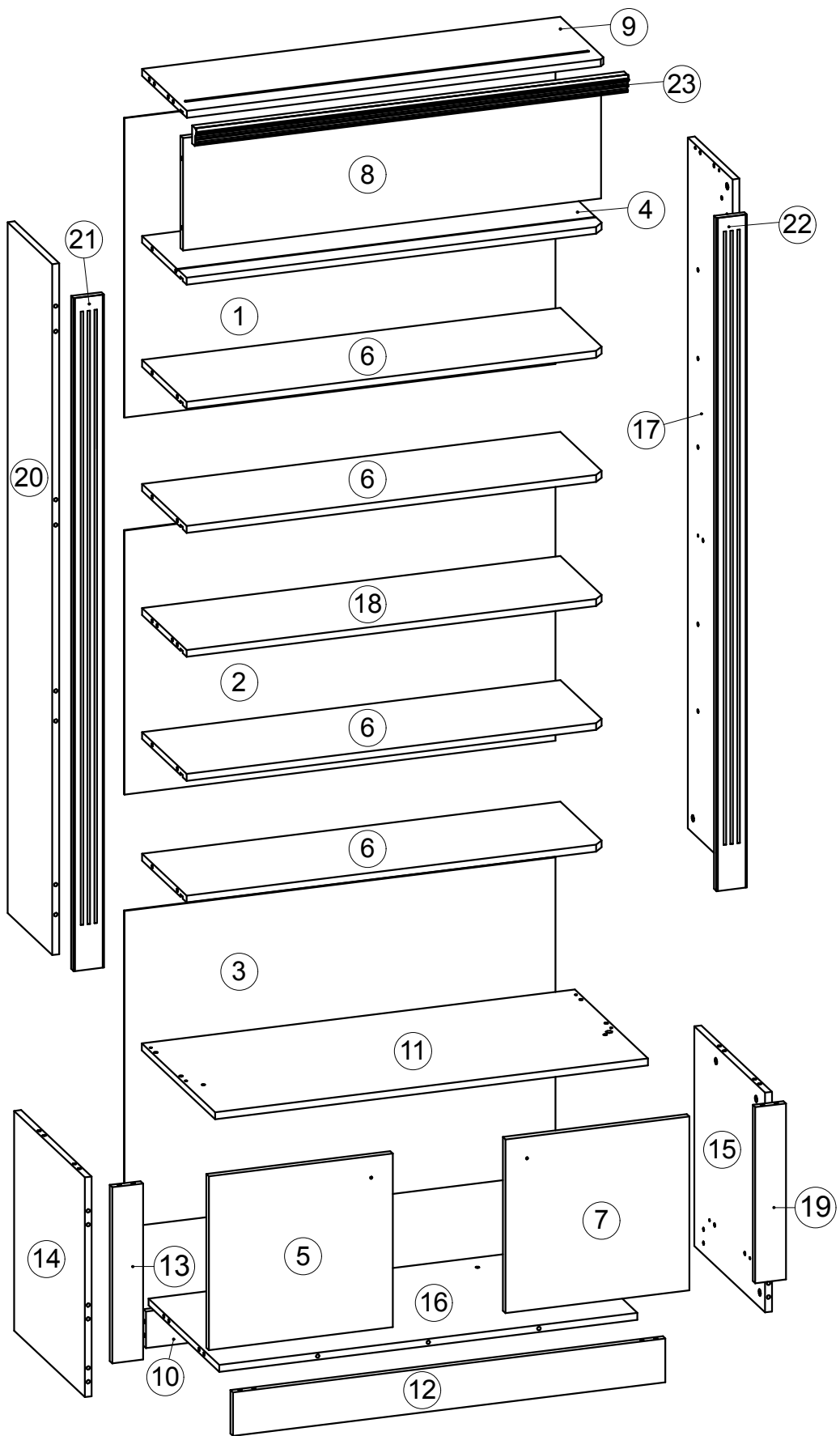

### Box 1

1000x42x28 mm

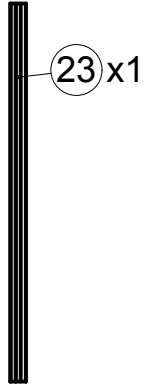

100x1000x16 mm

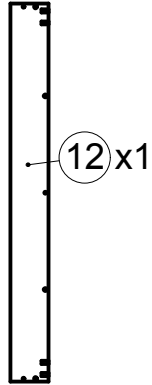

260x968x16 mm



968x284x16 mm

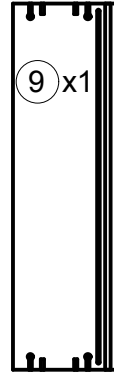

401x425x16 mm

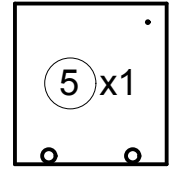

1001x465x16 mm

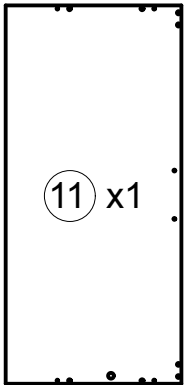

968x449x16 mm

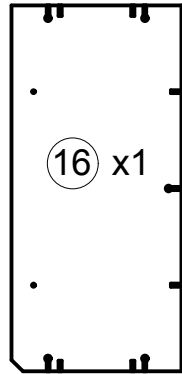

508x449x16 mm

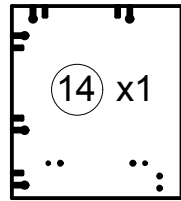

508x449x16 mm

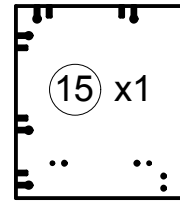

401x425x16 mm

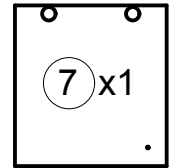

Fittings & Tools

### Box 3

693x998x3 mm

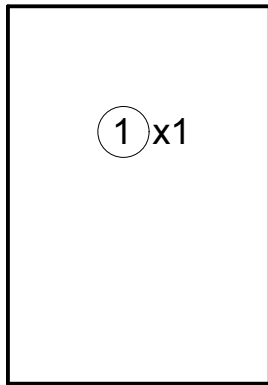

611x998x3 mm

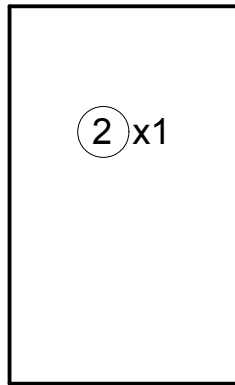

732x998x3 mm

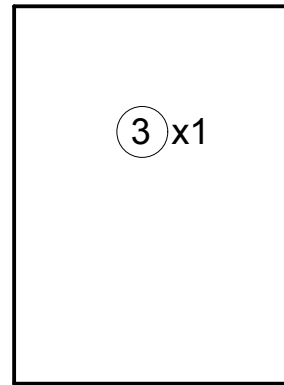

968x283x16 mm

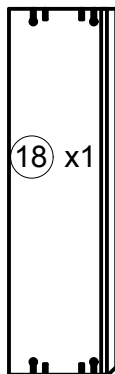

968x283x16 mm

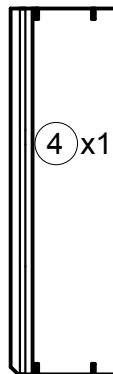

968x283x16 mm

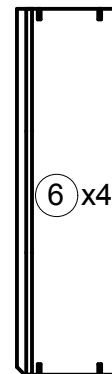

# Box 2

1598x284x16 mm

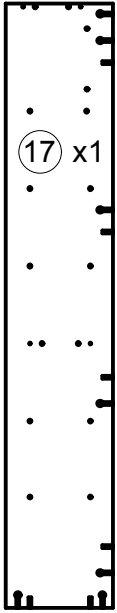

1598x284x16 mm

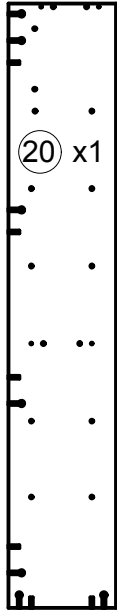

1560x73x16 mm

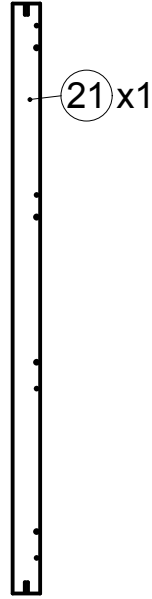

1560x73x16 mm

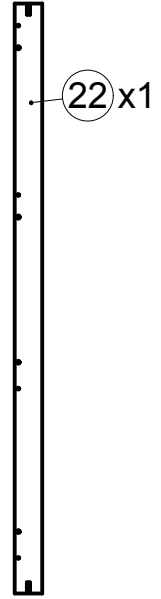

84x968x16 mm

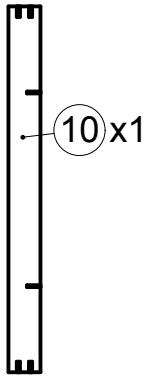

407x70x16 mm 407x70x16 mm

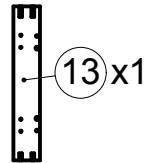
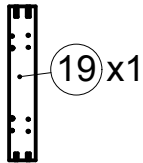

1

- A1 x 2
- A2 x 2
- A3 x 1
- B1 x 4
- B2 x 4
- B3 x 4
- G x 8

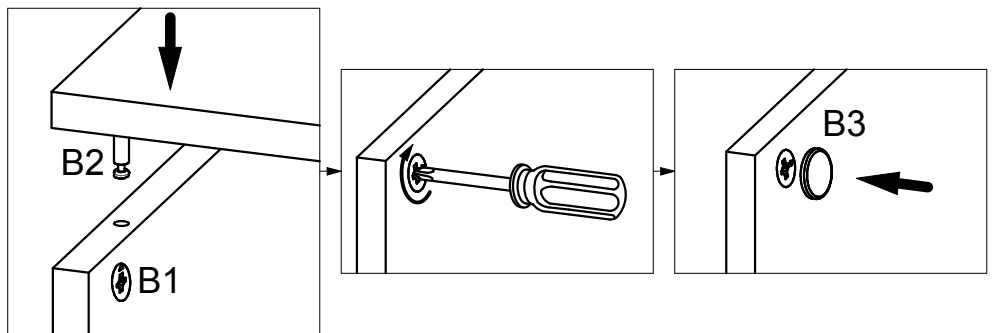
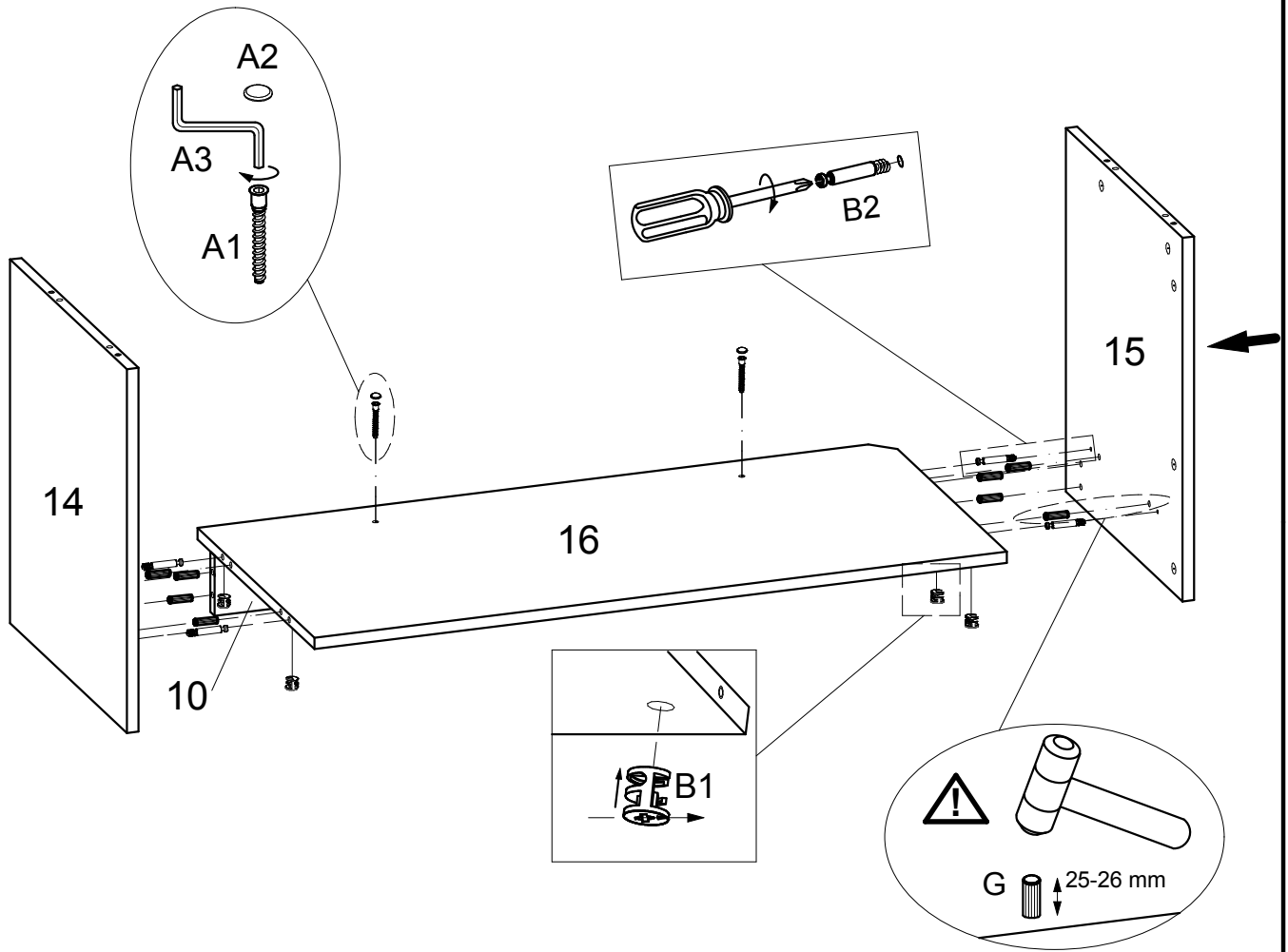
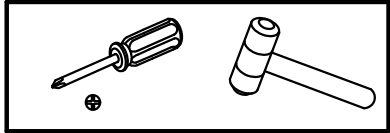

2



D1 x 8



M.1 x 4

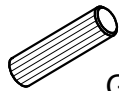

G x 4

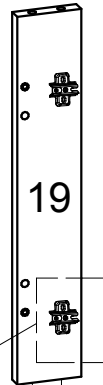
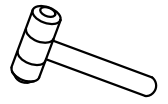
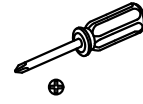

19

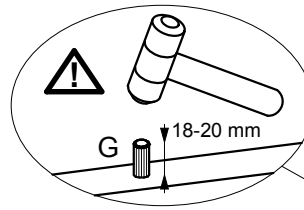

13

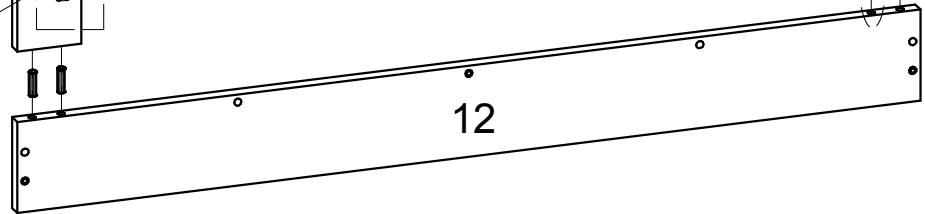

12

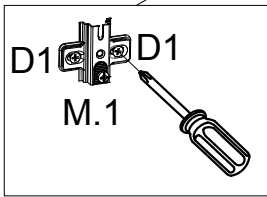

D1 D1  
M.1



3

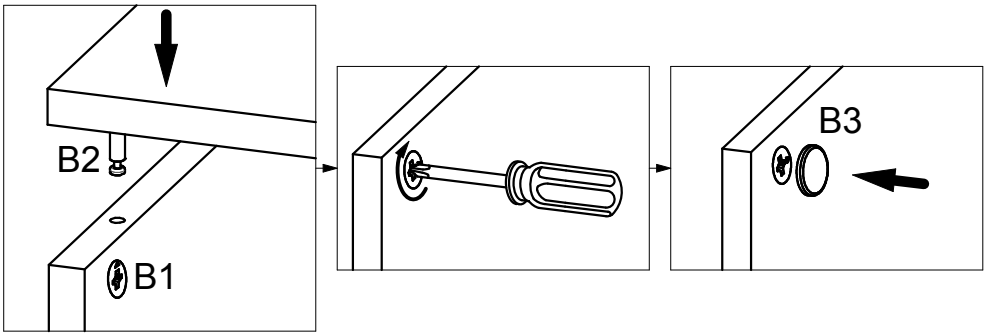
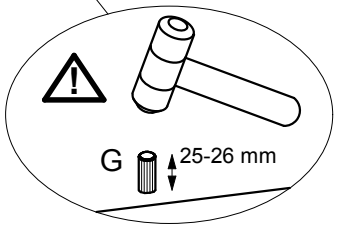
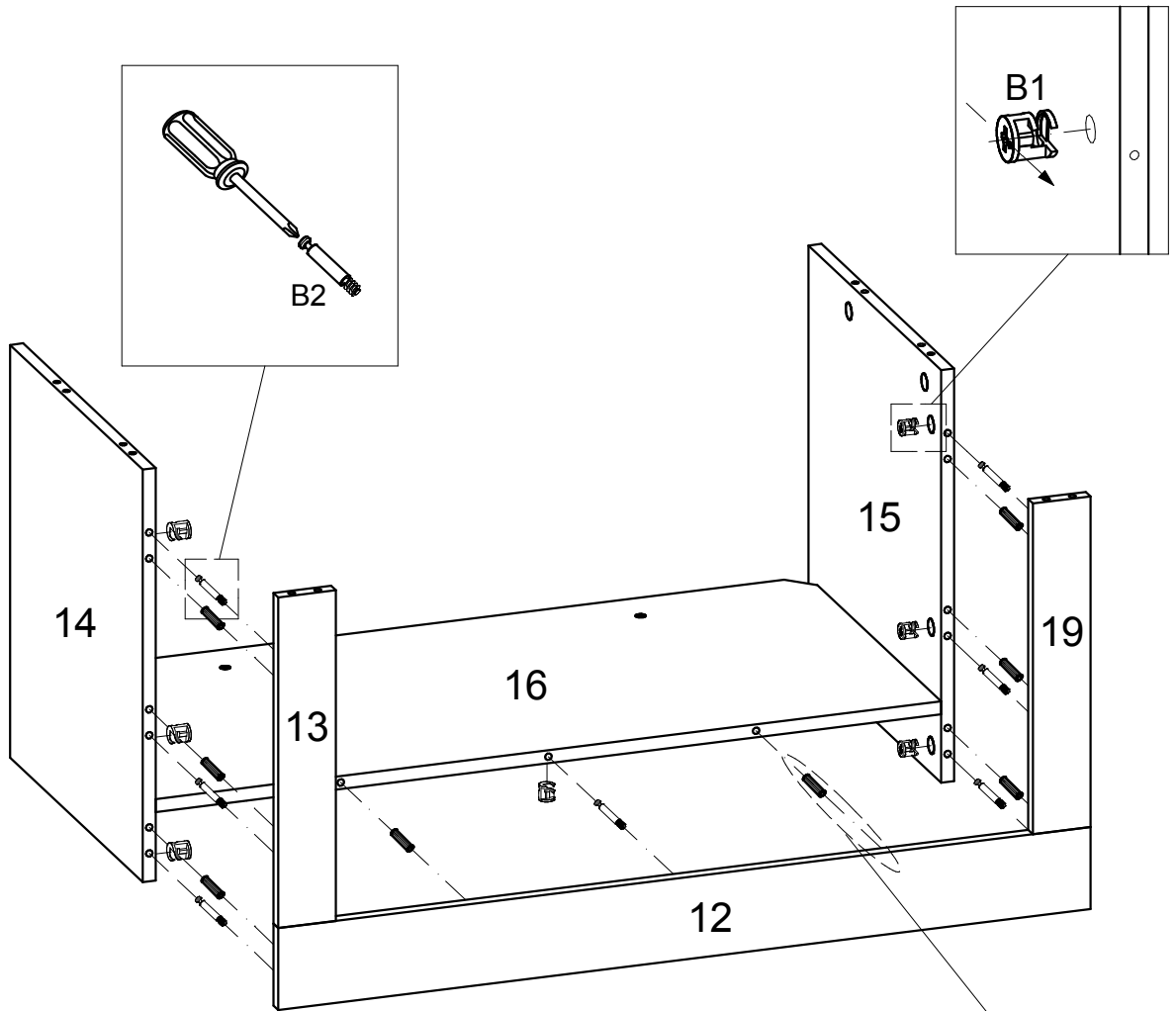
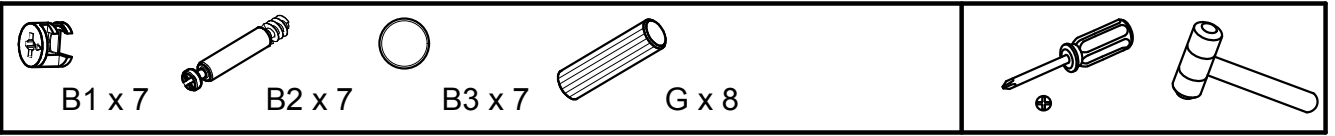

4

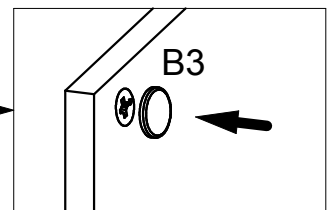
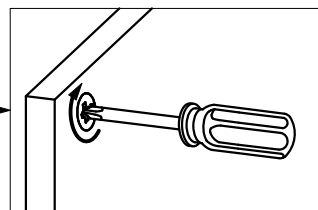
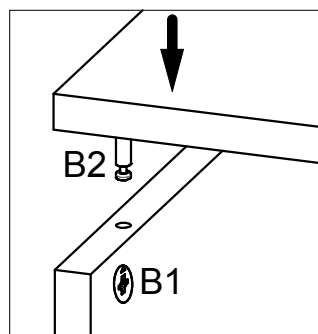
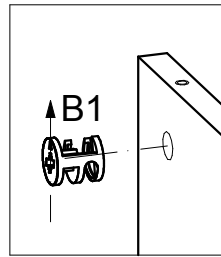
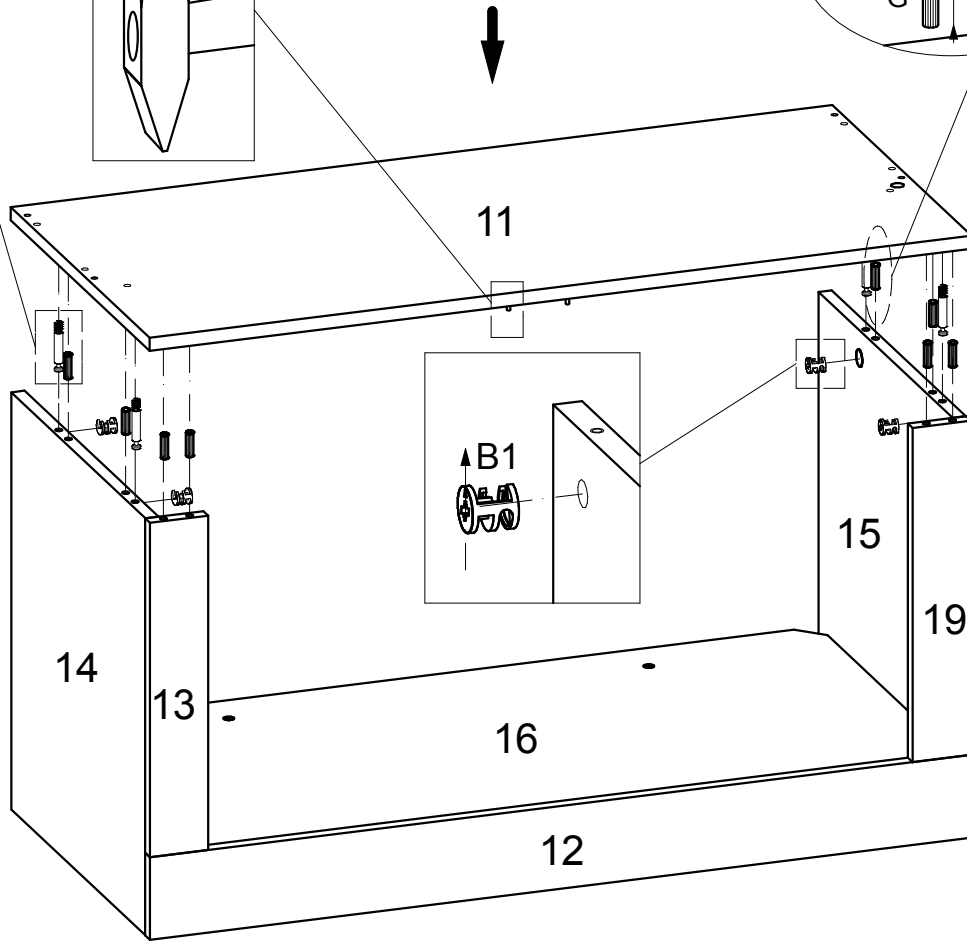
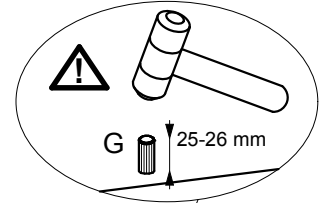
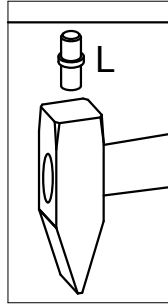
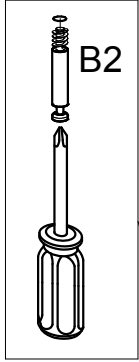
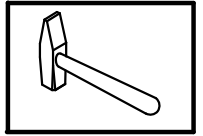
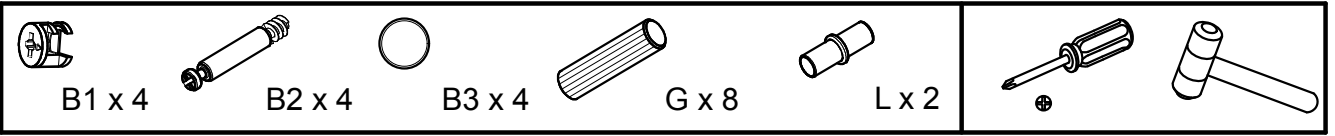

5

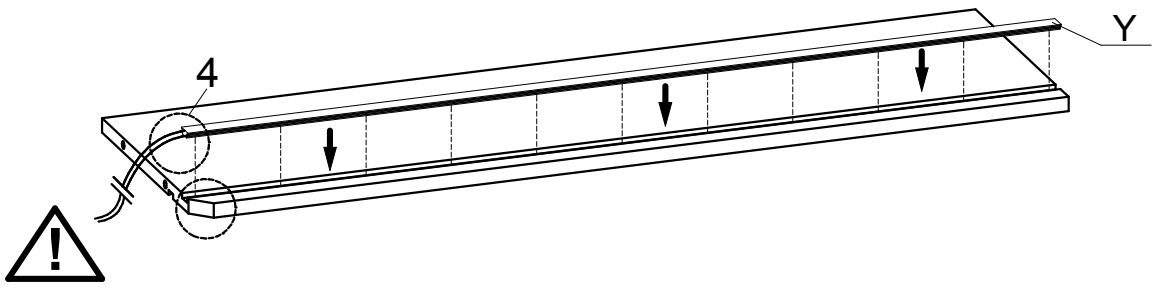
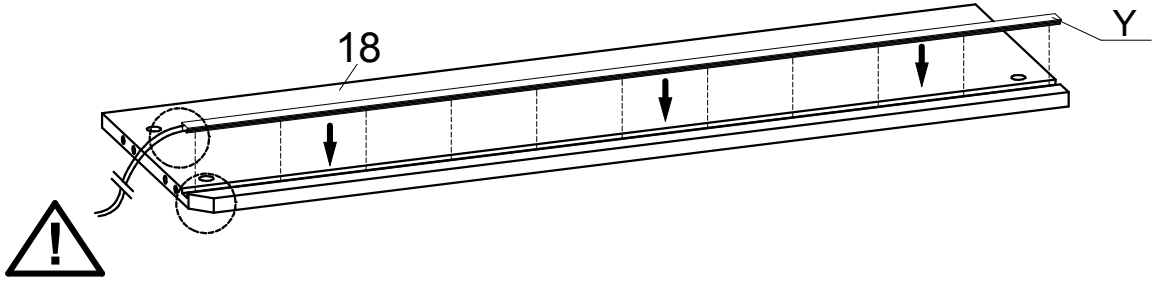
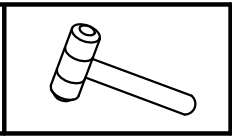

6

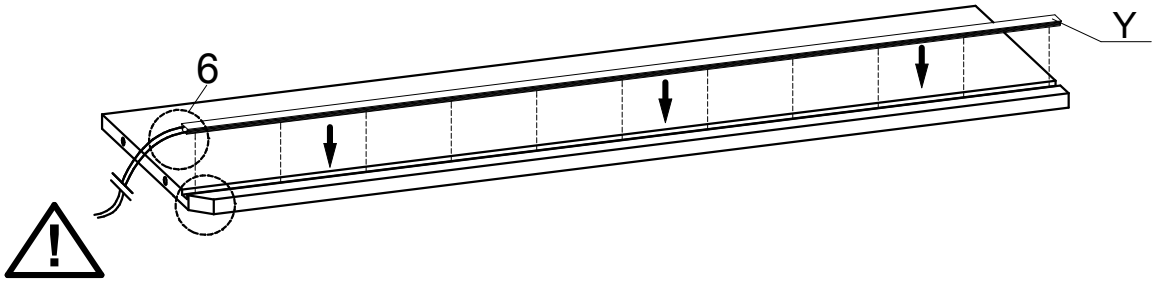
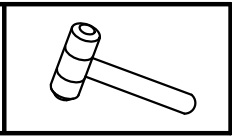

x 4

7



B1 x 8

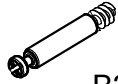

B2 x 8



B3 x 8

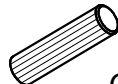

G x 32

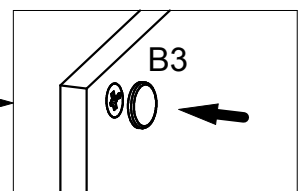
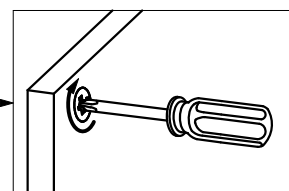
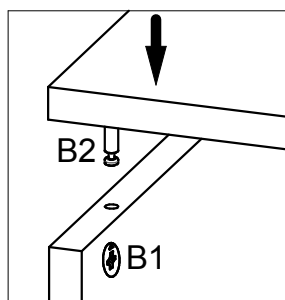
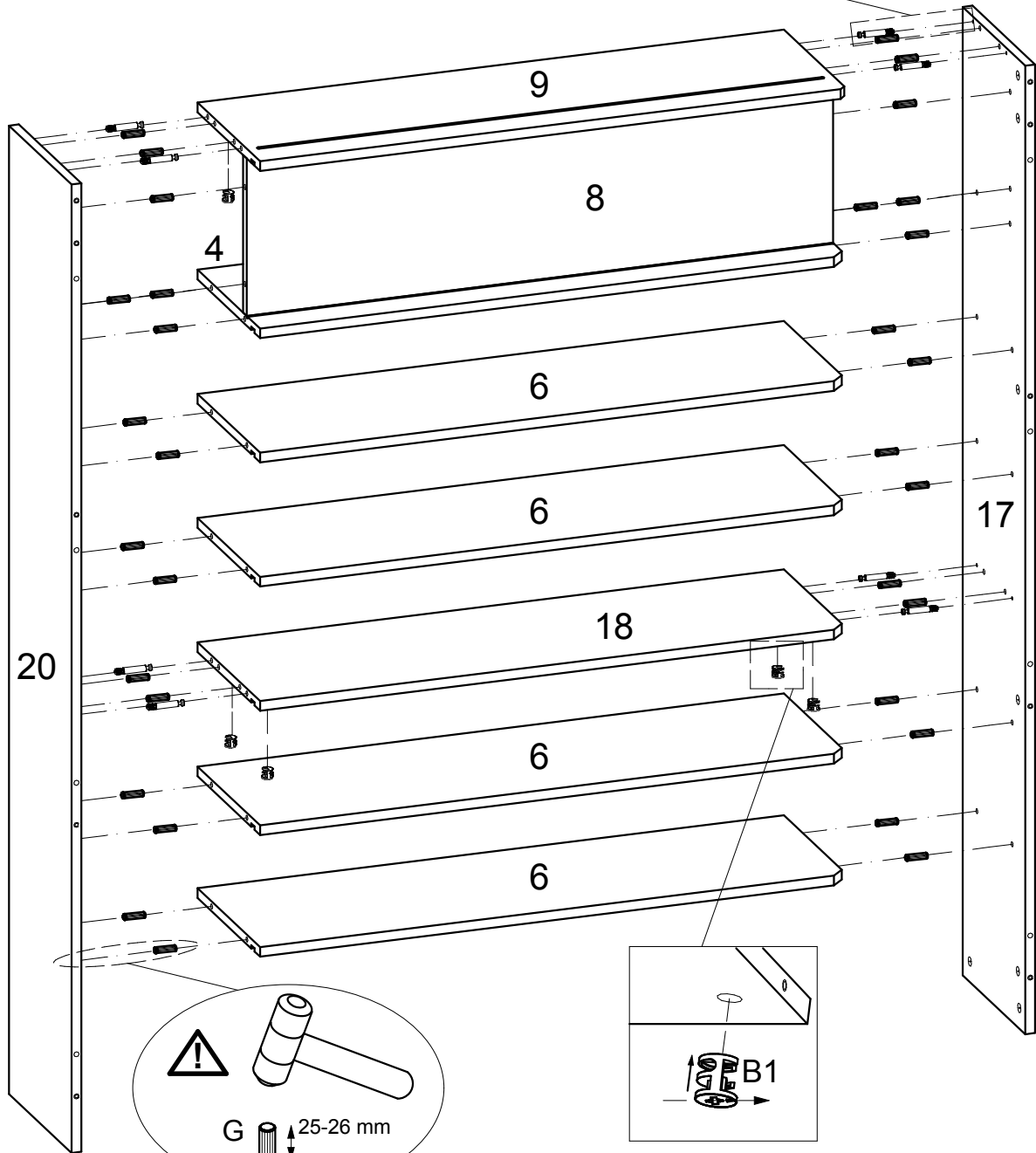
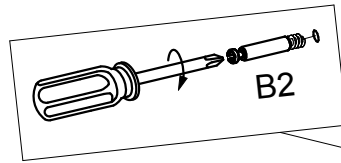
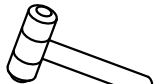
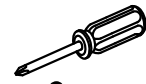

8

G x 2

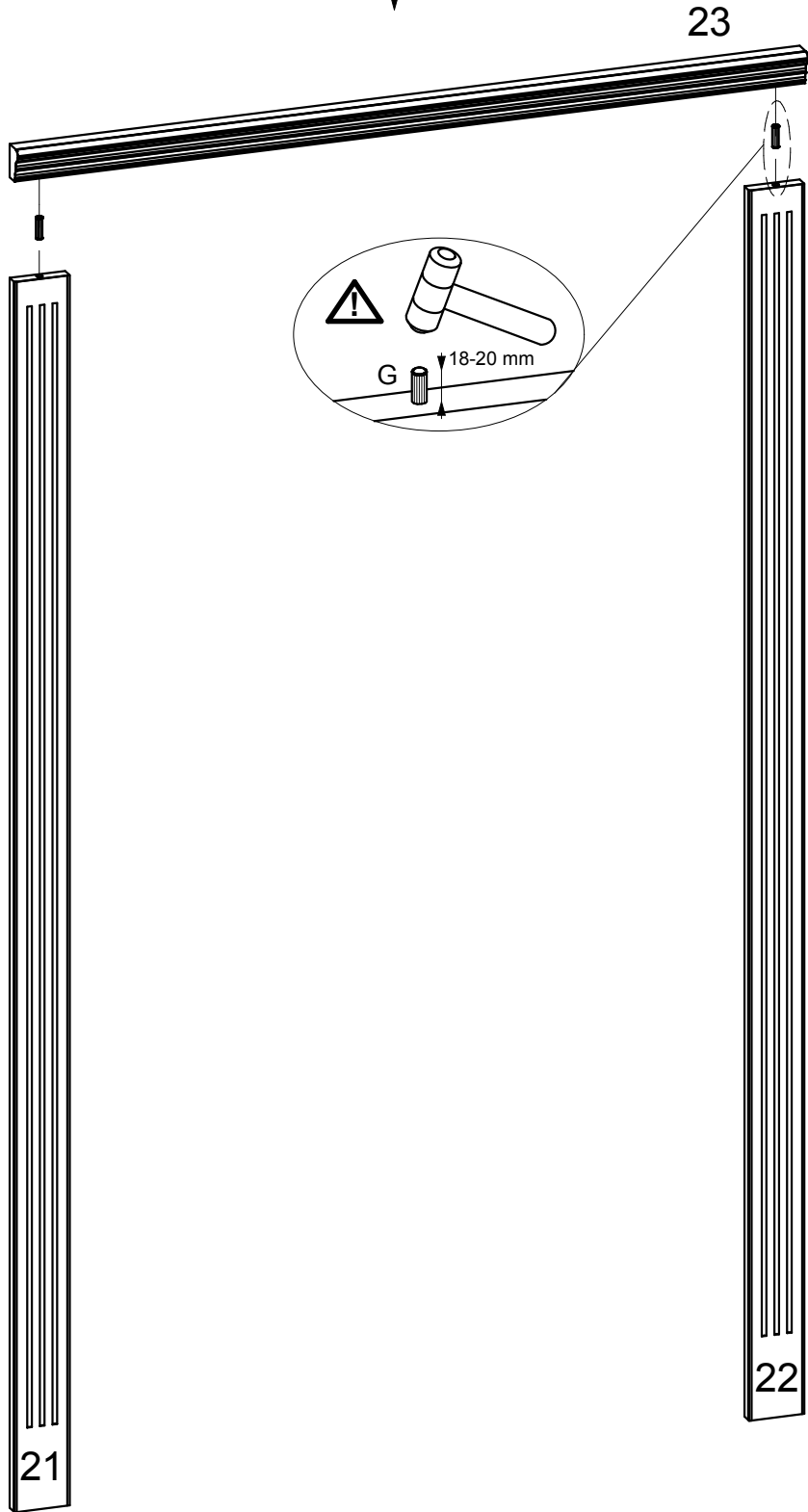
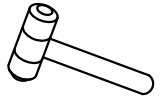

9



B1 x 10

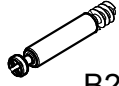

B2 x 10



B3 x 10

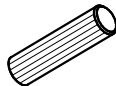

G x 8

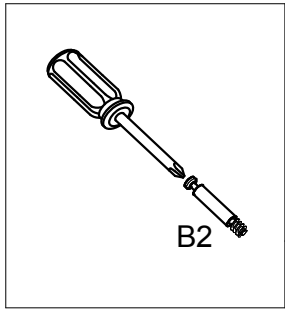
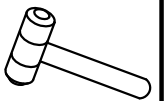
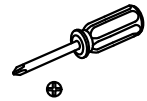

B2

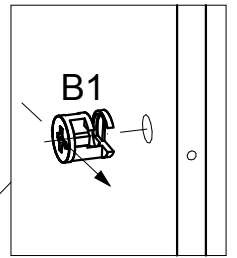

B1

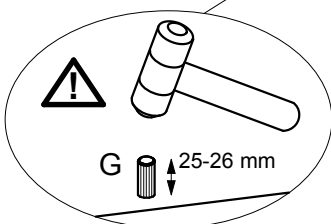
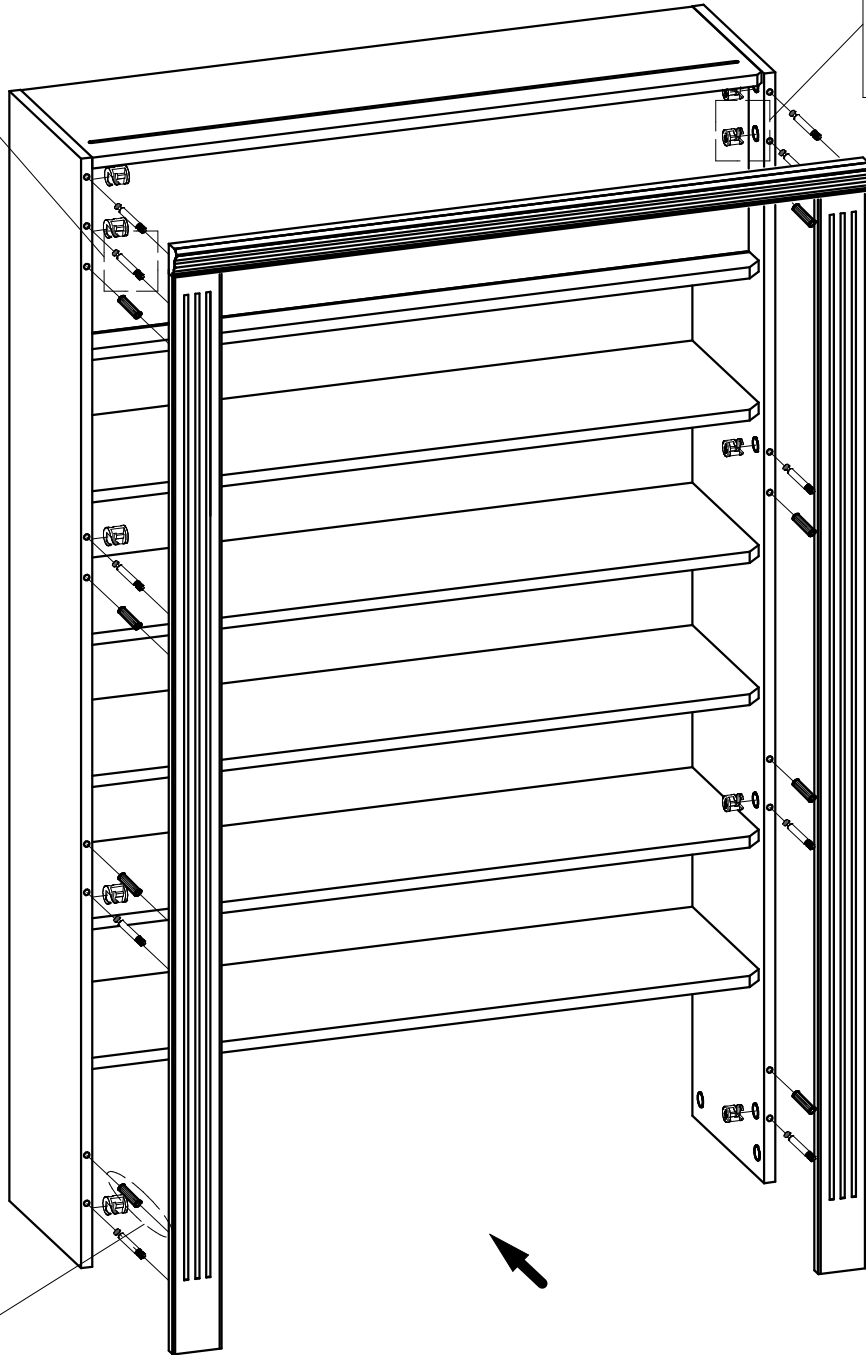

G

25-26 mm

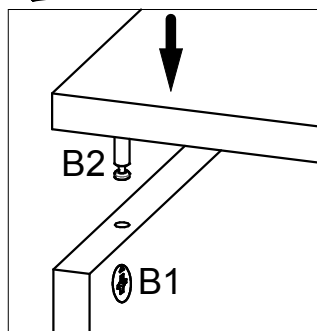

B2

B1

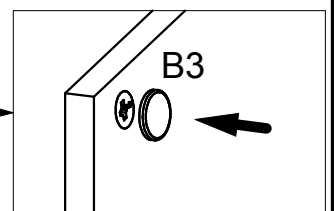
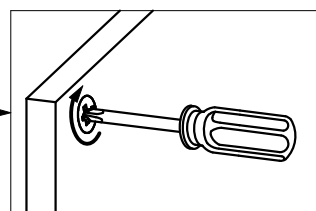

B3

10

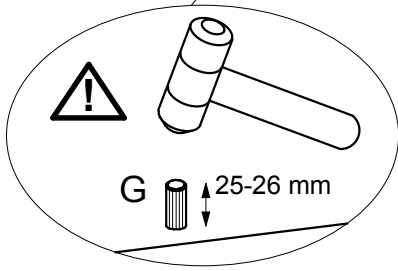
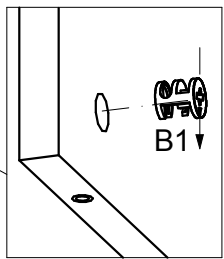
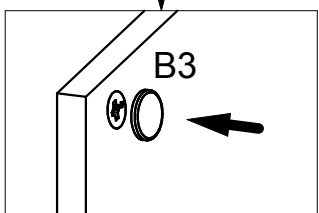
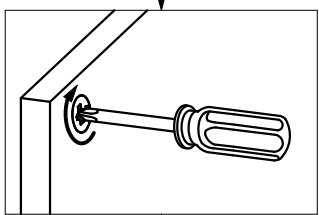
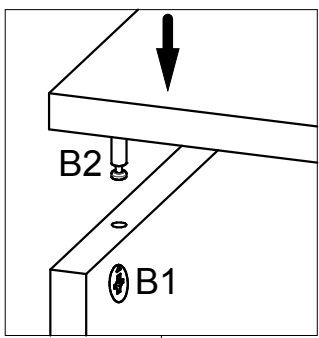
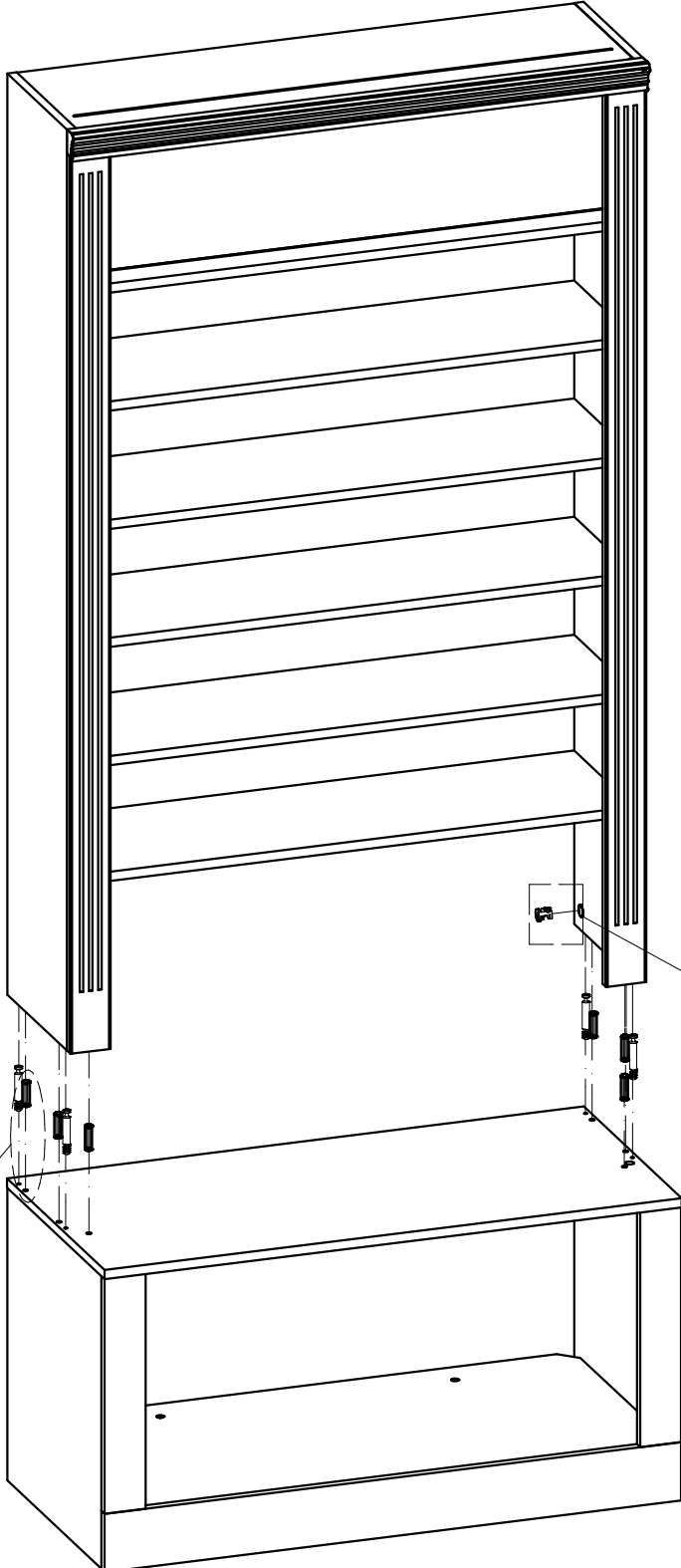

11

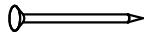

F x 125



N x 6

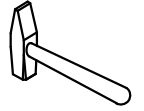

$XX=YY=90^\circ$

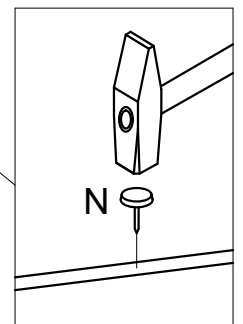
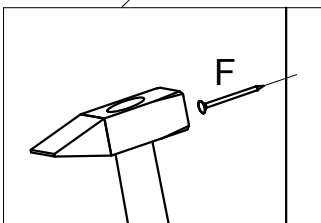
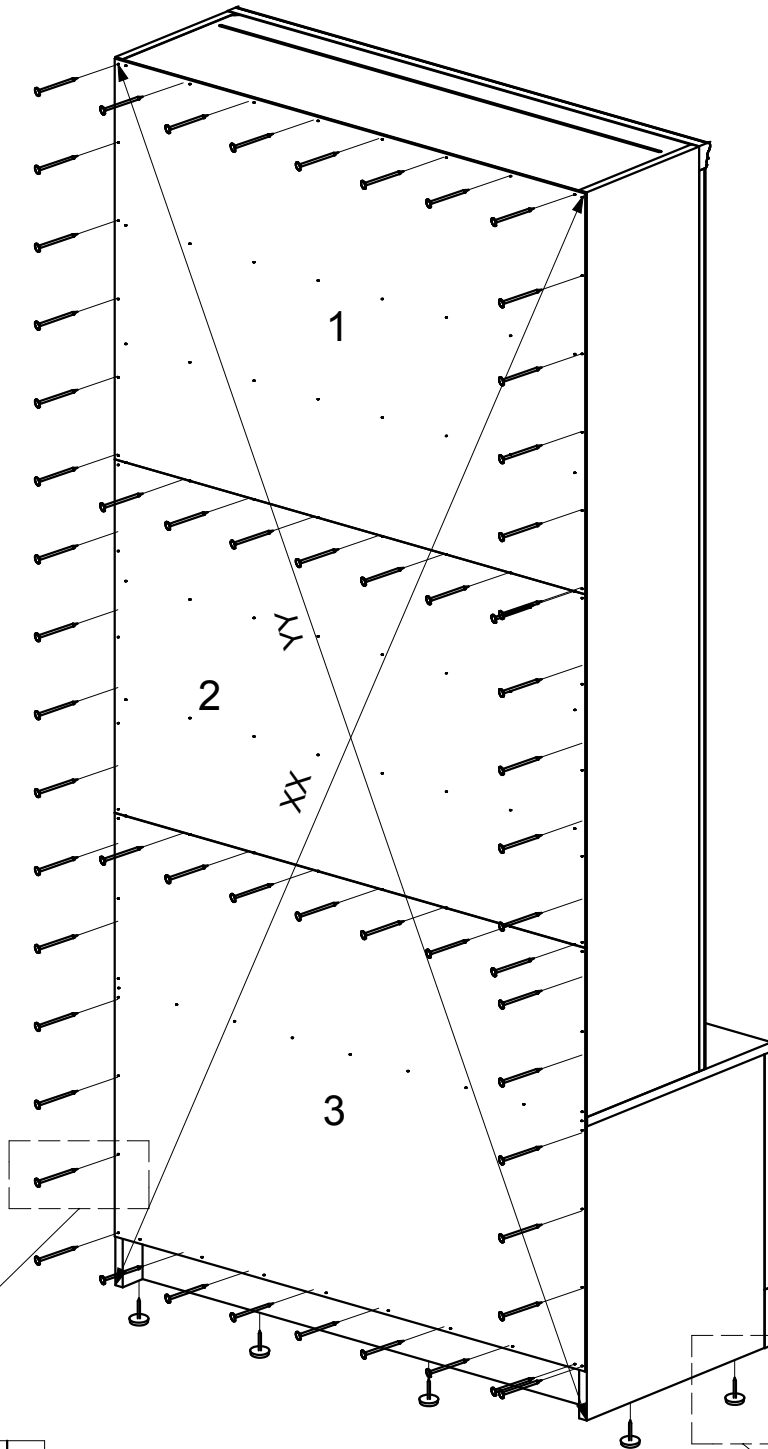



12



D1 x 8



D2 x 2



H x 2



M.2 x 4

